

# BACK BAR COOLERS



## EBB – Series

• EBB23 • EBB59 • EBB69 • EBB90



EBB23



EBB59



EBB69



EBB90

### Cabinet Construction

Heavy duty stainless steel countertop, textured and laminated black vinyl exterior. Galvanized steel interior wall, and high quality stainless steel floor. 1 3/4" thick high density foamed-in-place polyurethane insulation. Pre-installed four 4" diameter casters for single door unit. Built-in caster thread receptacles for all units.

### Refrigeration System

- Back mounted condensing unit for single door, and side mounted condensing unit for two and three door models
- Oversized condenser and evaporator coils quickly achieve and maintain desired temperature
- Forced-air cooling with oversized evaporator fan motors providing balanced airflow throughout cabinet to ensure faster temperature drop
- Removable side panel and slide-out condensing unit for convenient repair and maintenance
- Environmentally friendly CFC free R-134A refrigerant
- Air defrost controlled by electrical timer
- Copper tube and aluminum fin evaporator with anti-corrosive coating
- Energy efficient condensate drain pan assembly heated by high side copper tube
- Pre-wired and ready to plug, 115V/60Hz/1Ph, NEMA 5-15P

### Doors

- Textured and laminated black exterior with galvanized steel interior
- 1 3/4" thick high density foamed-in-place polyurethane insulation
- One piece snap-in magnetic door gaskets for easy replacement
- Heavy duty recessed door handles for a flat surface
- Door locks

### Lighting

- Shielded vertical LED interior lighting with on/off switch for energy saving, less heat generation and enhanced illumination (available from 2015 models except model EBB23)

### Shelving

- Two epoxy coated wire shelves per section
- Stainless steel pilasters and shelf clips

### Temperature Control

- Factory preset temperature, 35°F
- Temperature setting range from 32°F to 42°F
- Easy to set analog thermostat

### Options

- 2 1/2" and 4" diameter casters (3 1/2" and 5" overall height) optional for all models except EBB23

• Project / Customer \_\_\_\_\_

• Item No. \_\_\_\_\_

• Model No. \_\_\_\_\_

### Warranty

 **5 Year — Compressor Warranty**  
**3 Year — Parts & Labor Warranty**  
Applicable to units purchased after July 1, 2014.

### Contact

 201 W. Artesia Blvd, Compton, CA 90220  
T. (310) 323-6586, (800) 444-6285  
F. (310) 323-7524, (310) 761-1127

# BACK BAR COOLERS



## EBB – Series

• EBB23 • EBB59 • EBB69 • EBB90

### Dimensions

#### SIDE VIEW (All models except EBB23)

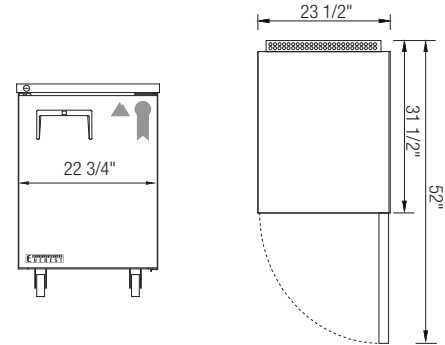
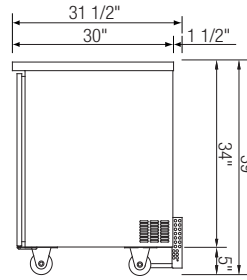
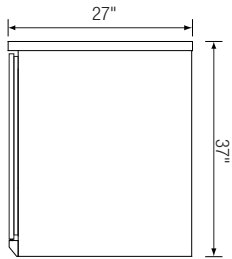

▲ EBB23

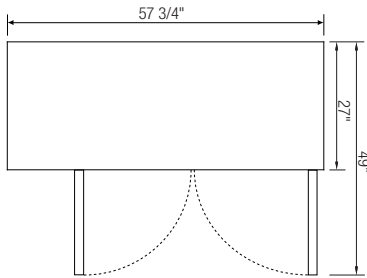

▲ EBB59

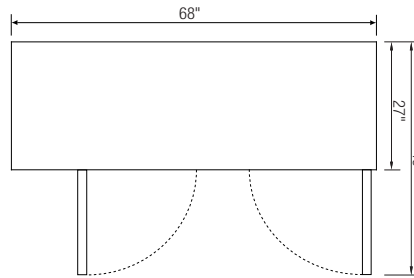

▲ EBB69

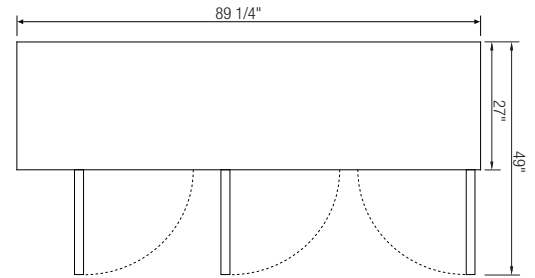

▲ EBB90

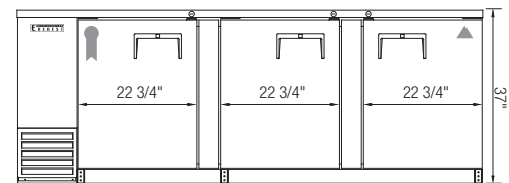
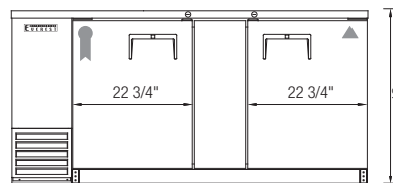
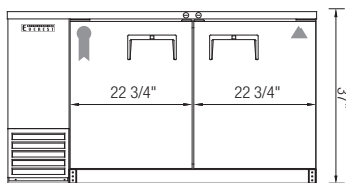

Model	Ref/ Frz/ Dual	# of Doors	Capacity (Cu.Ft.)	HP	Refrigerant	# of Shelves	Capacity		Power (V-Hz-Ph)	Amps	Crated Weight (LBS)	Exterior Dimensions (Inches)			* Height includes 5" for casters  † Depth includes 1 1/2" for back grill  Ref = Refrigerator Frz = Freezer Dual = Ref & Frz Combo
							12 oz. Cans	12 oz. Bottles				L	D	H	
EBB23	Ref	1	8.19	1/6	R-134A	2	220	125	115-60-1	3.90	158	23 1/2	31 1/2 <sup>†</sup>	39*	
EBB59	Ref	2	20.09	1/4	R-134A	4	640	408	115-60-1	4.20	297	57 3/4	27	37	
EBB69	Ref	2	24.01	1/4	R-134A	4	800	504	115-60-1	4.20	329	68	27	37	
EBB90	Ref	3	32.37	1/3	R-134A	6	1120	696	115-60-1	4.50	420	89 1/4	27	37	

Disclaimer: Product dimensions are for general purposes and not absolute value. Slight variations may exist. If dimensions are critical, please contact Everest.